

Pipe- and Cable trunking, TRL Aluminium, PVC

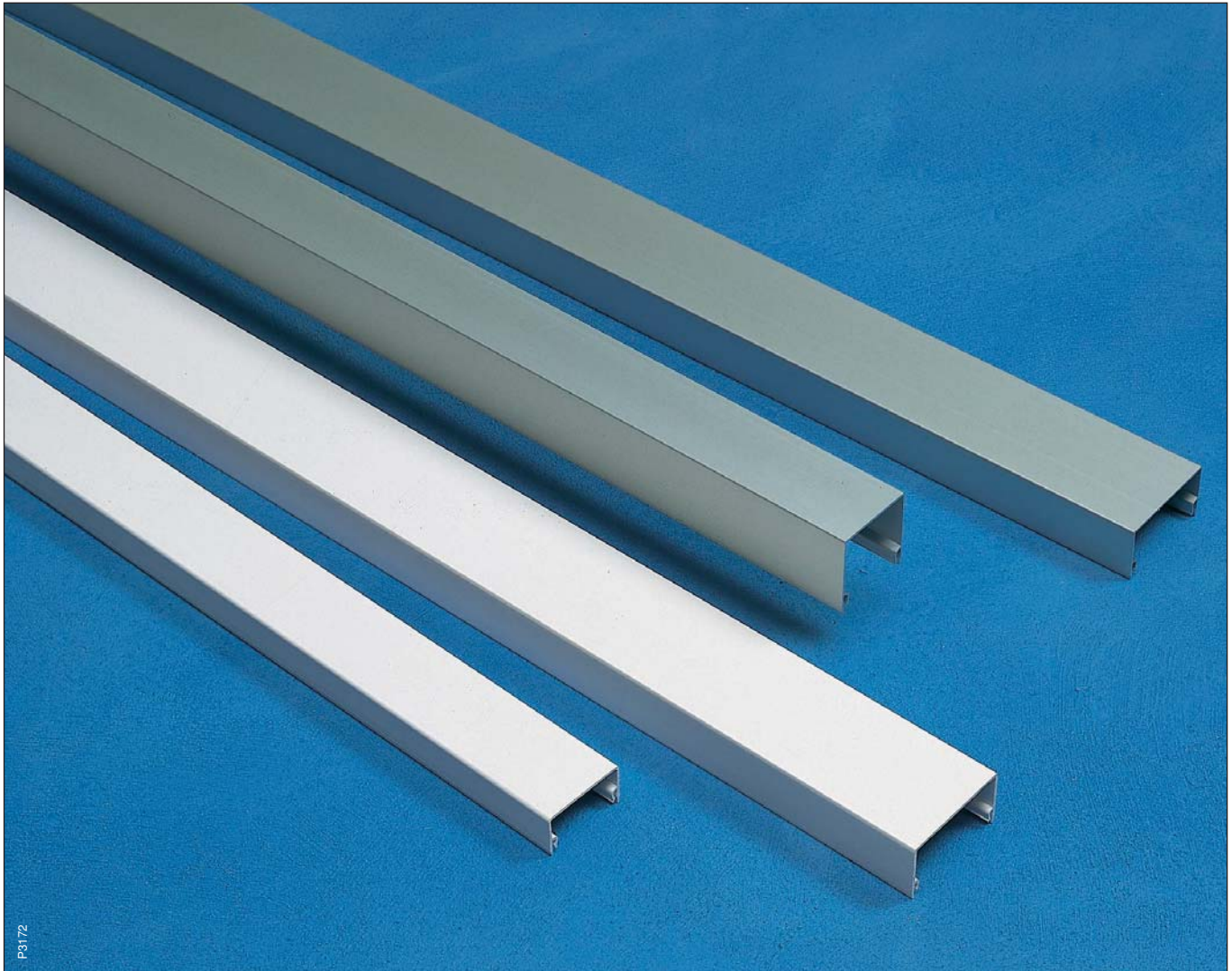

Basic data

Description

Pipe and wiring trunking made of rigid PVC or aluminium. Used to conceal heating pipes, wiring and cables. TRL is in the form of a cover that is fixed to the backing with base clamps. Pipes, cables etc are fixed to base clamps with self-locking ties, for quick, stable and attractive installation. The cover is available in several sizes.

Benefits

- The base clamp is designed to be used with plumbing and electrical installations – a broad range of application
- Snap-on fitting and self-locking ties for very quick, easy installation
- Base clamps with ties fix cables and pipes, while the cover simply conceals the installation
- Cables and pipes can be installed at an early stage
- Easy to add to while building is in progress
- No risk of damage to cover, since it can be snap-fitted at a late stage in the building project.

Material and colour

White RAL 9016 rigid selfextinguishing, cadmium- and lead-free PVC or natural anodized aluminium¹⁾.

Temperature range

PVC –20 °C to +60 °C.

Accessory range

For TRL there are base clamps with ties, loose ties, jointing pieces, stop-end, collar and clamp. See the "Product range" table.

Lengths supplied

2,5 metres.

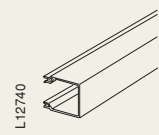
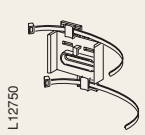
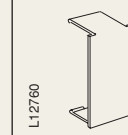
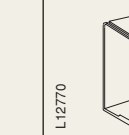
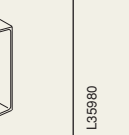
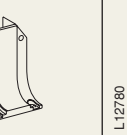

¹⁾ On special order the trunking can be painted in any shade listed in the NCS and RAL colour ranges (see page 6).

Product Range, type TRL

In the matrix: Type Art. No. Material/Finish	 L12740	 L12750	 L12760	 L12770	 L35980	 L12780
TRL-	Cover	Base clamp	Jointing piece	Stop end	Collar	Clamp
5630	TRL-D5630 5321 100 AN 5320 100 PV	TRL-H56 5322 010 POBL	TRL-S5630 5322 160 POV 5322 162 POG	TRL-ES5630 5322 110 POV 5322 112 POG	TRL-KN5630 5322 410 POV 5322 414 POG	TRL-B5630 5322 550 AN 5322 553* AN
5656	TRL-D5656 5321 120 AN	TRL-H56 5322 010 POBL	TRL-S5656 5322 172 POG	TRL-ES5656 5322 122 POG	TRL-KN5656 5322 420 POV 5322 424 POG	TRL-B5656 5322 551 AN
7640	TRL-D7640 5321 210 AN 5320 210 PV	TRL-H76 5322 020 POBL	TRL-S7640 5322 180 POV 5322 182 POG	TRL-ES7640 5322 130 POV 5322 132 POG	TRL-KN7640 5322 430 POV 5322 434 POG	TRL-B7640 5322 552 AN

* Double for two TRL-D5630 covers.

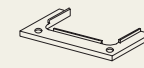
Accessories, type TRL

Type	Art. No.	Material/Finish
Base plate For collar TRL-KN. To be fitted at collar at floor penetrations to seal, for instance, against water.		
 TRL-TKN 5676	5322 450	POBL
Tie (loose)		
 TRL-T	5322 050	POBL
Torx special screw Used when installing clamps and collar for secure locking of TRL cover. Can only be unscrewed with a special tool. The Torx screw is supplied with an M-anchor.		
 ISV-S1 (screw)	5900 400	SO
ISV-T1 (tool)	5900 410	SO

Construction, type TRL

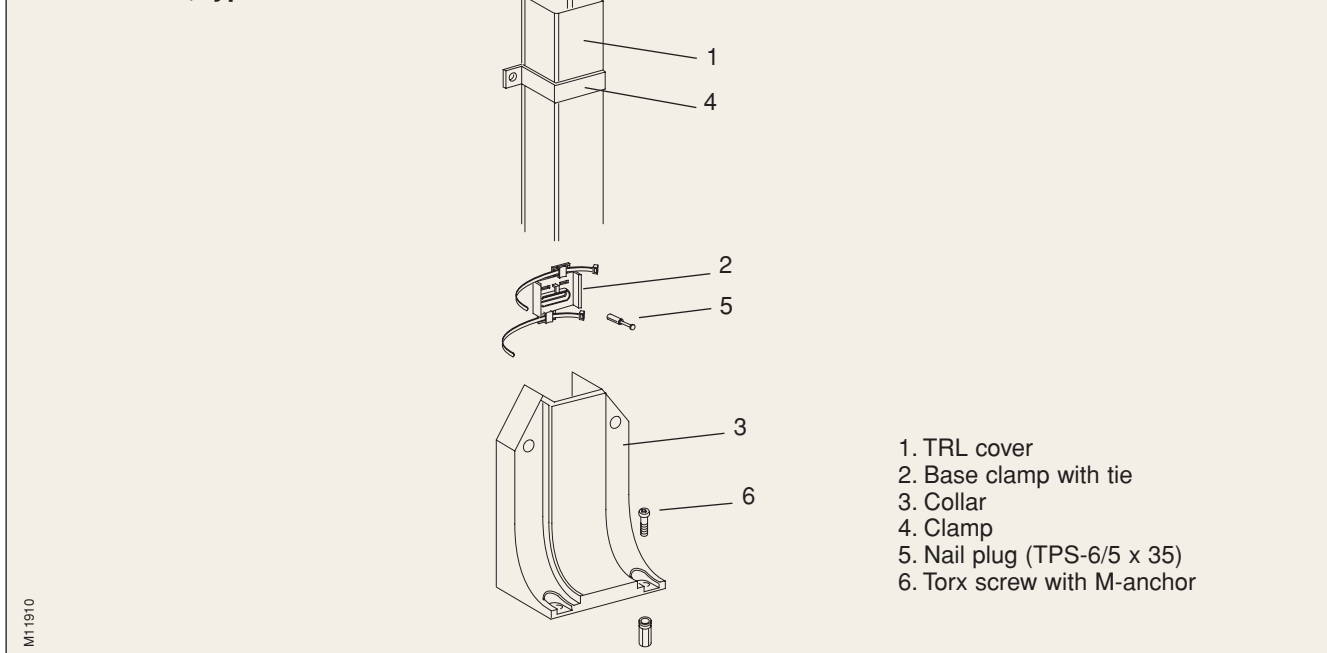

AL= Aluminium, untreated
 AN= Aluminium, natural anodized
 AF= Aluminium, foiled (page 7)
 PC= Powder coated (page 6)

PV= PVC white (RAL 9016)
 PR= PVC white (RAL 9010)
 PG= PVC grey
 PB= PVC brown

PCLG= Powder coated, light grey metallic
 POV= Plastic other, white
 POR= Plastic other, white RAL 9010
 POG= Plastic other, grey

POBL= Plastic other, black
 POBR= Plastic other, brown
 POT= Plastic other, transparent
 PO= Plastic other, colour undefined

GS= Galvanized Steel
 SO= Steel, other
 ← = Left hand → = Right hand
 ↑ = Up, riser ↓ = Down, dropper